

USER MANUAL

用户手册



MELO SV

READ CAREFULLY AND KEEP WITH THE CASE
使用前请仔细阅读本手册，并妥善保存以备日后查阅

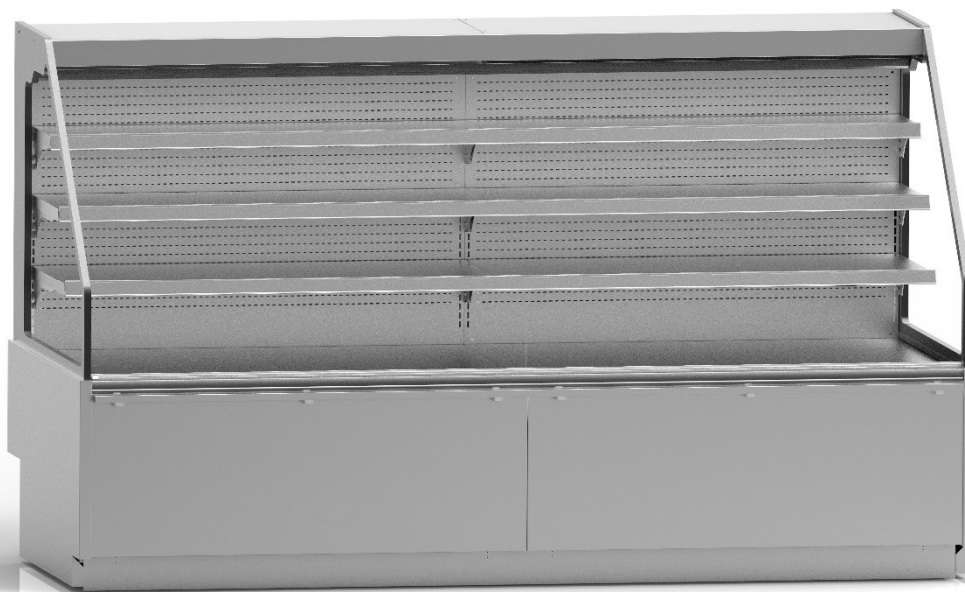

Rev. B - 2023.6.30

INTRODUCTION / 简介

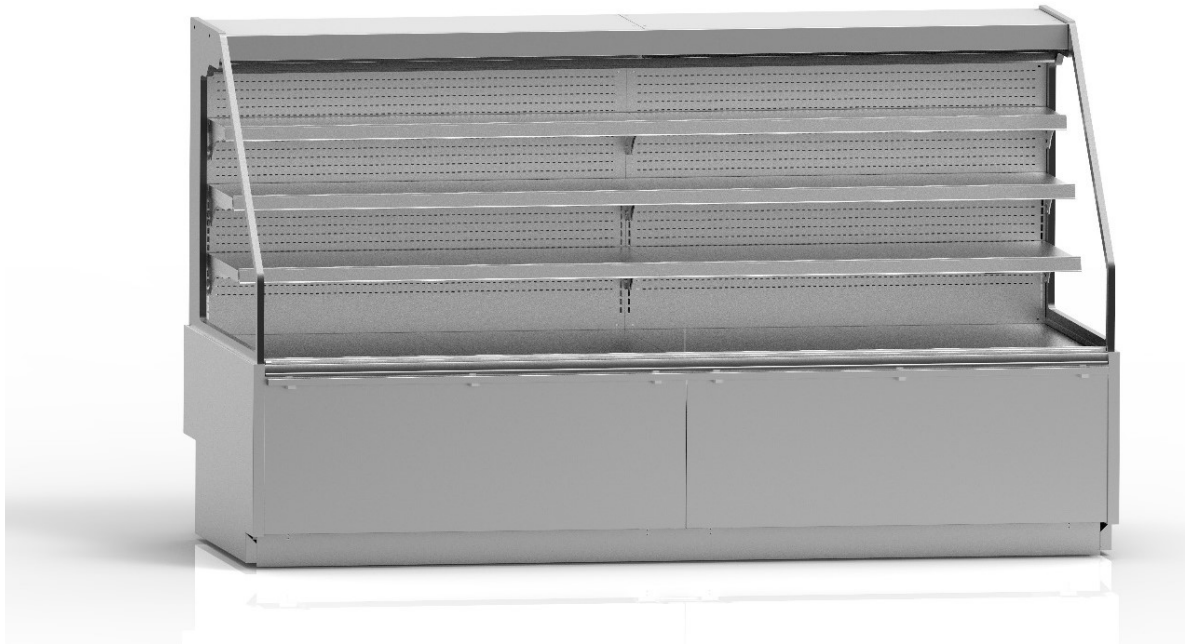

The present booklet has been formulated in a simple and rational way, for the reader to get deeply acquainted with this showcase. Please, read it carefully and keep it with the machine. **The manufacturer assumes no responsibility for any personal injury or property damage which may be caused by non-compliance with the instructions contained in this booklet. Whoever operates the machine must have read this manual beforehand.**

本说明书简明扼要的对产品进行阐述，用户可以深入了解产品。请在陈列柜使用前仔细阅读本说明书并妥善保管。厂商对未按照本说明书的操作而引起的人身伤害或者财产损失不承担任何责任。每位使用陈列柜的用户请务必在使用前仔细阅读本说明书。

General Description/总体描述

SV H11

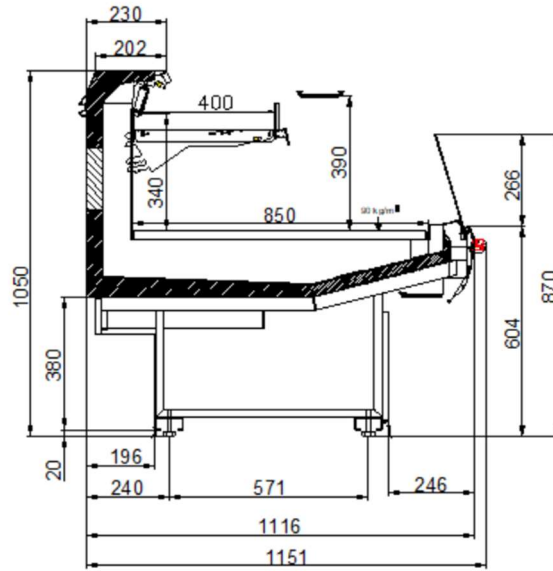

LS-C BC

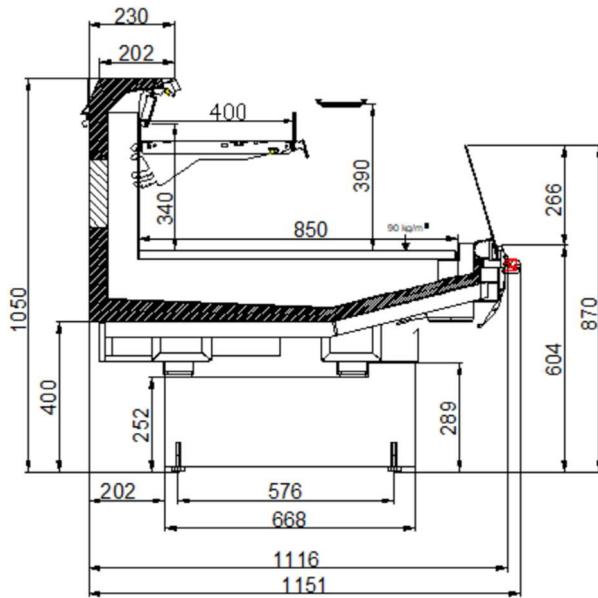

LS-C SB Oval

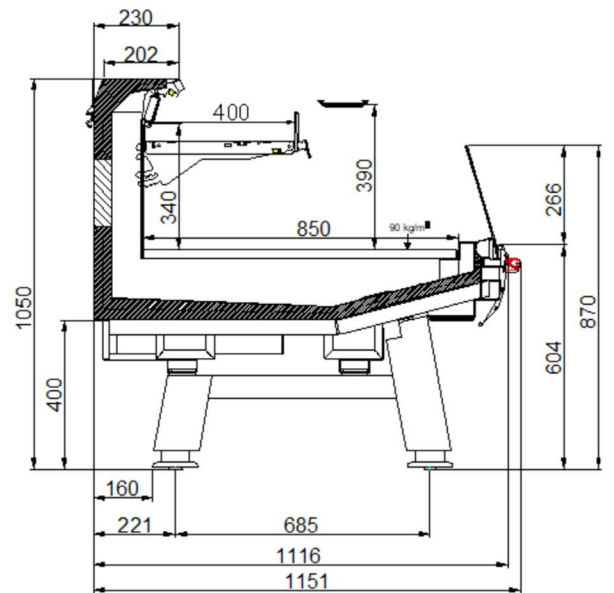

LS-C SB Slim

General Description/总体描述
SV H12

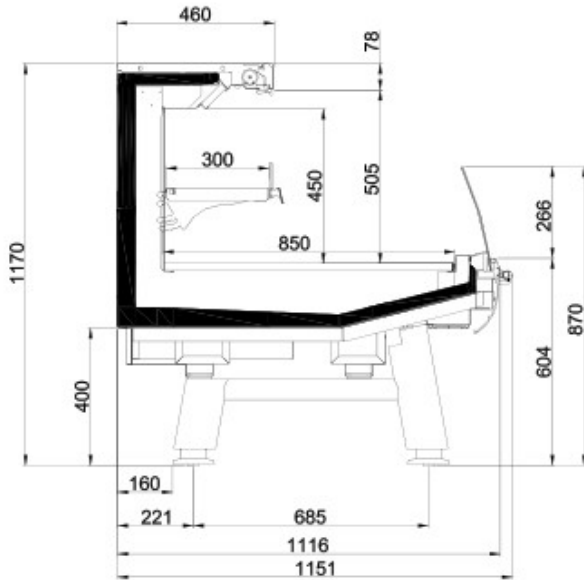

LS-C SB Slim

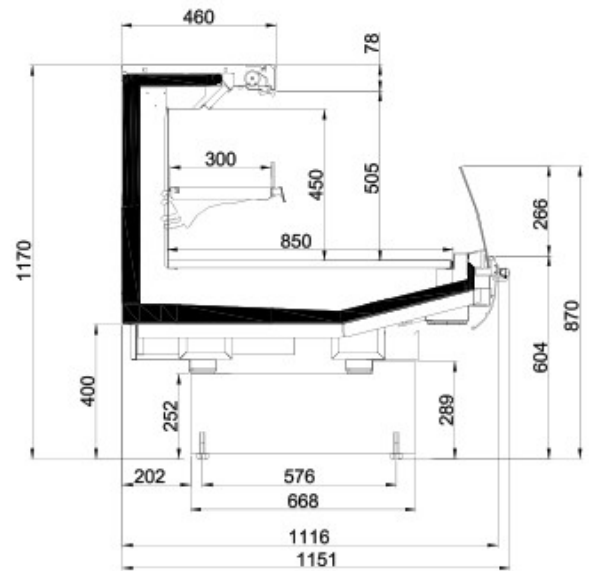

LS-C SB Oval

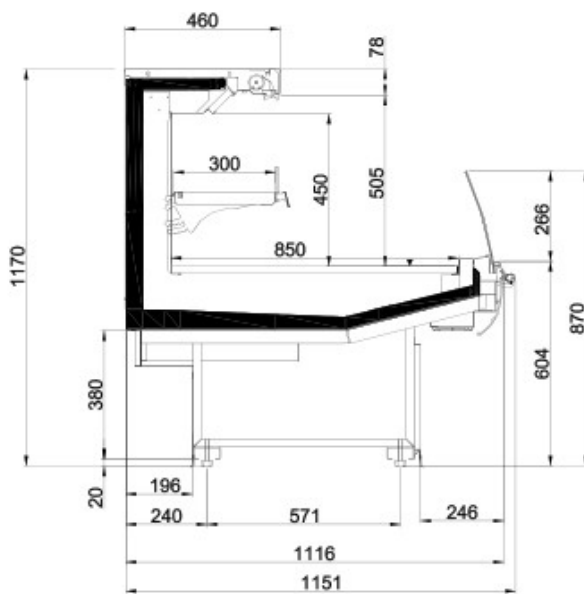

LS-C BC

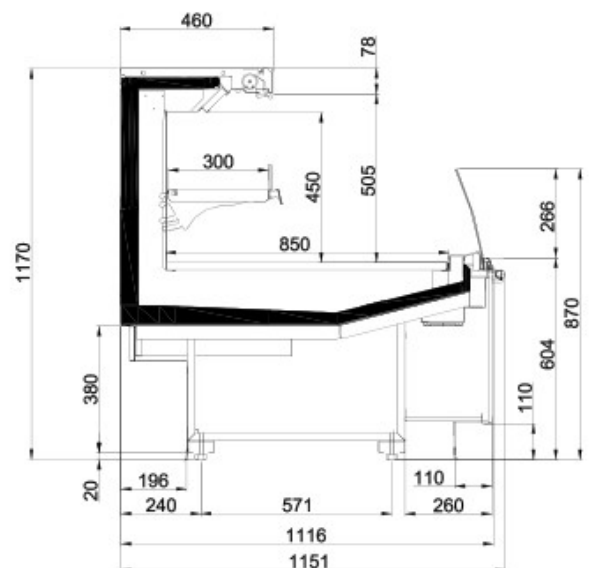

LS-C DESIGN

General Description/总体描述

SV H12

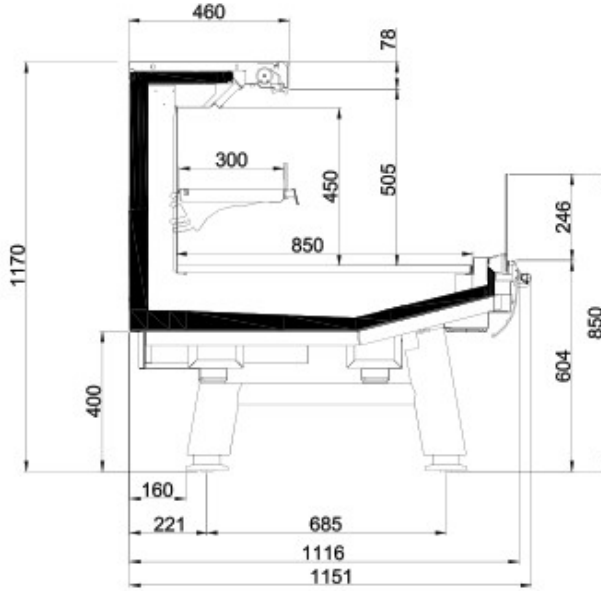

LS-D SB Slim

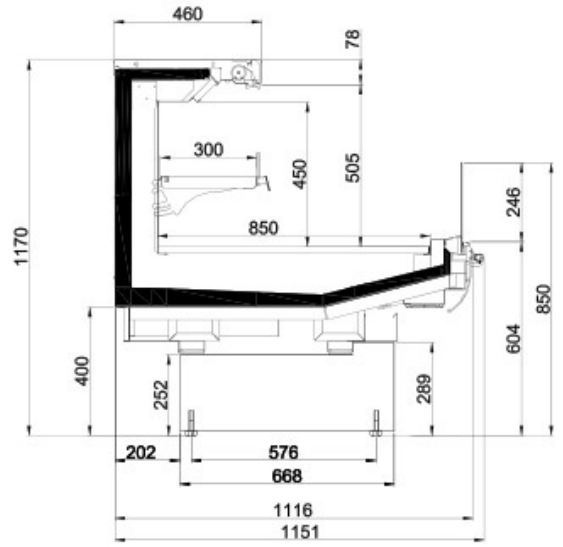

LS-D SB Oval

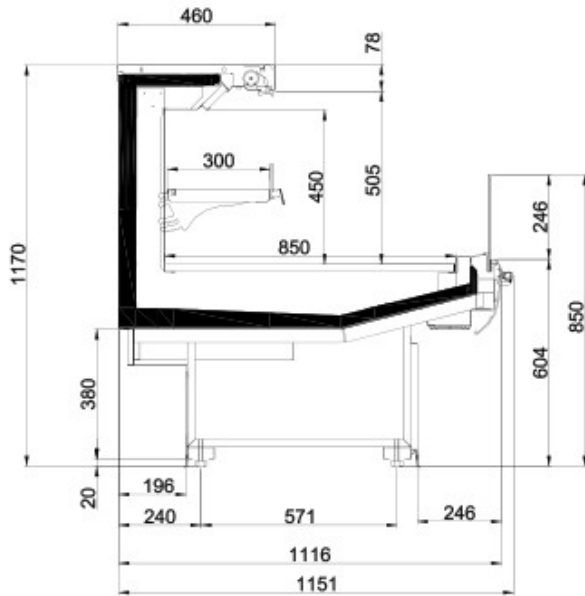

LS-D BC

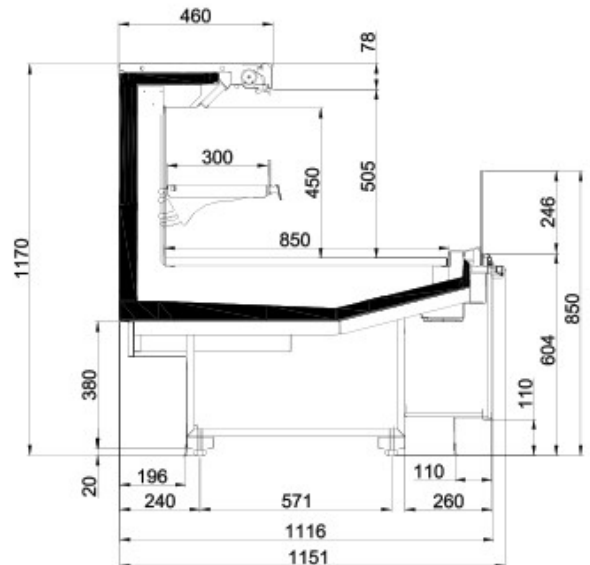

LS-D Design

General Description/总体描述

SV H13

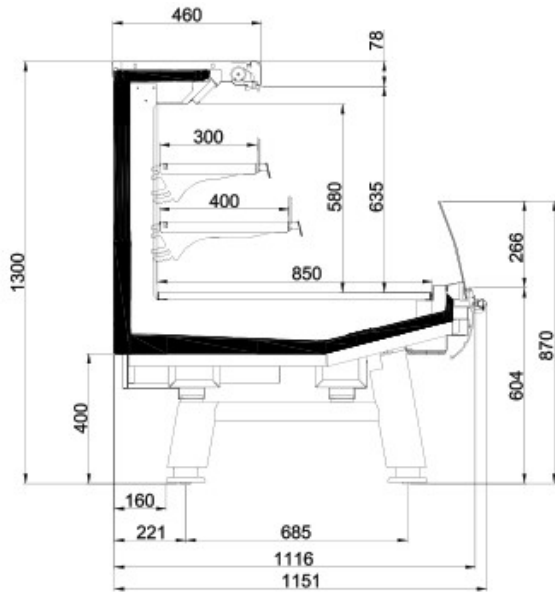

LS-C SB Slim

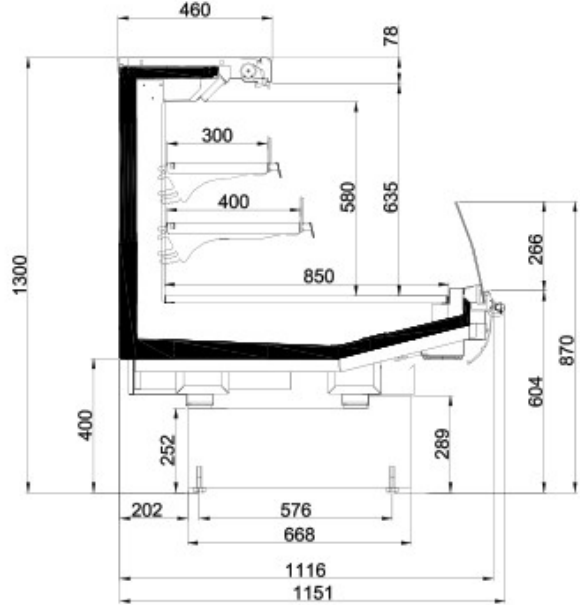

LS-C SB Oval

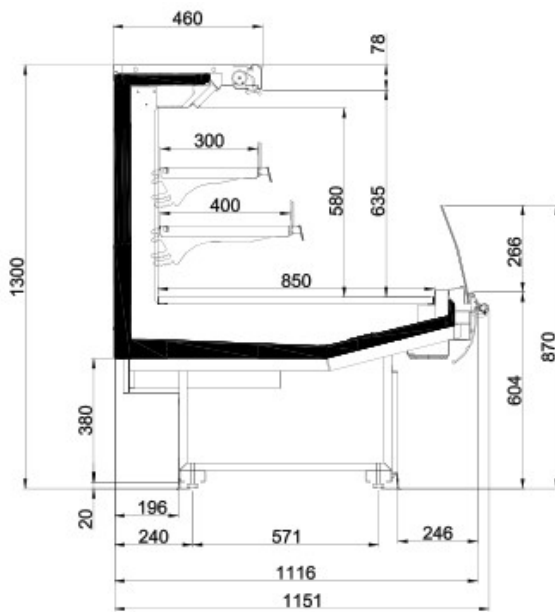

LS-C BC

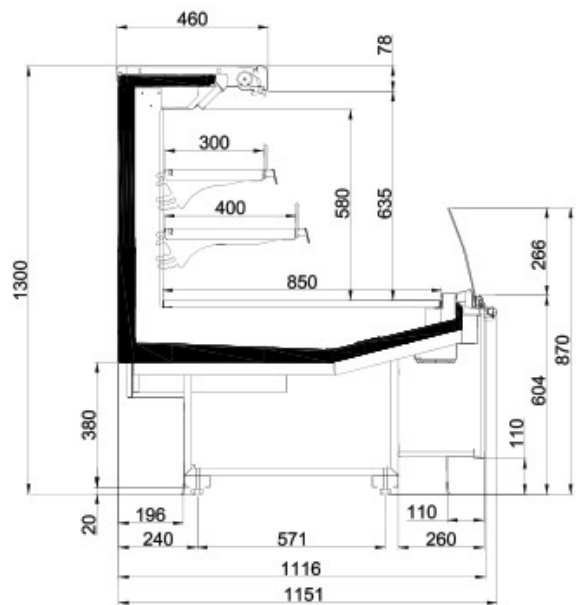

LS-C DESIGN

General Description/总体描述

SV H13

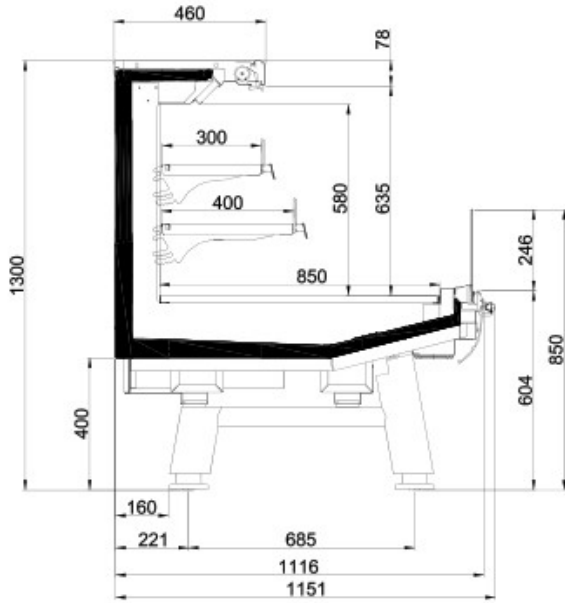

LS-D SB Slim

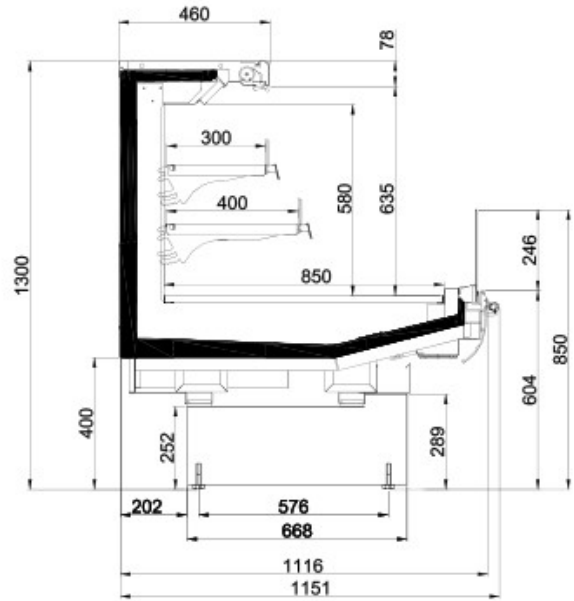

LS-D SB Oval

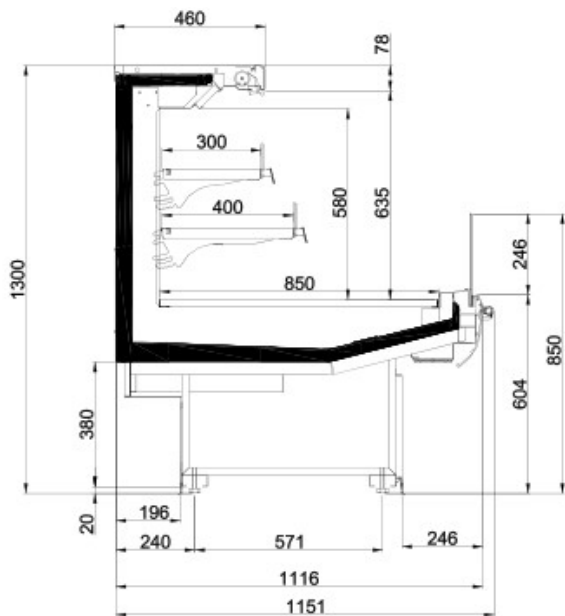

LS-D BC

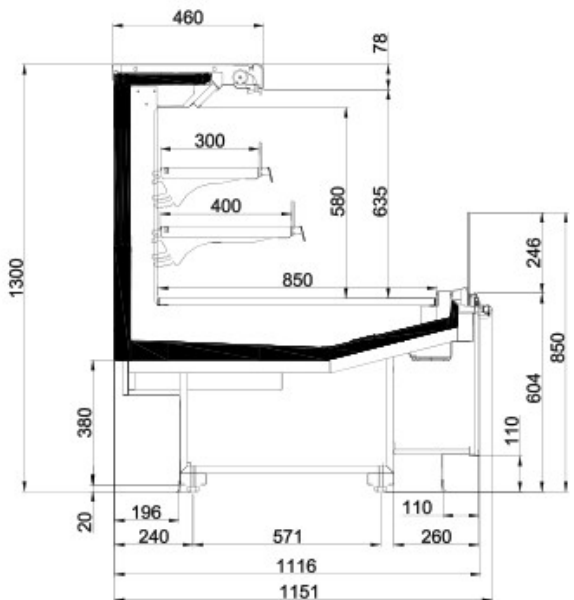

LS-D Design

General Description/总体描述

SV H15

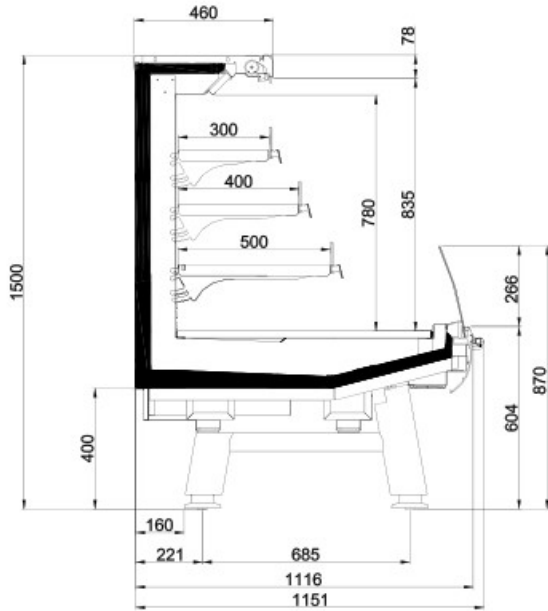

LS-C SB Slim

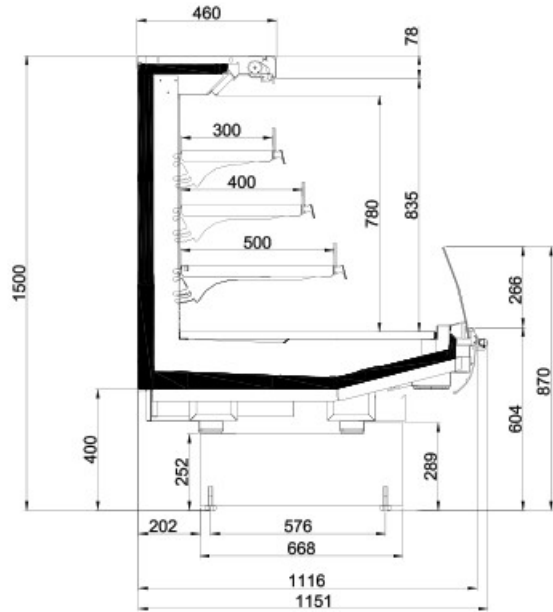

LS-C SB Oval

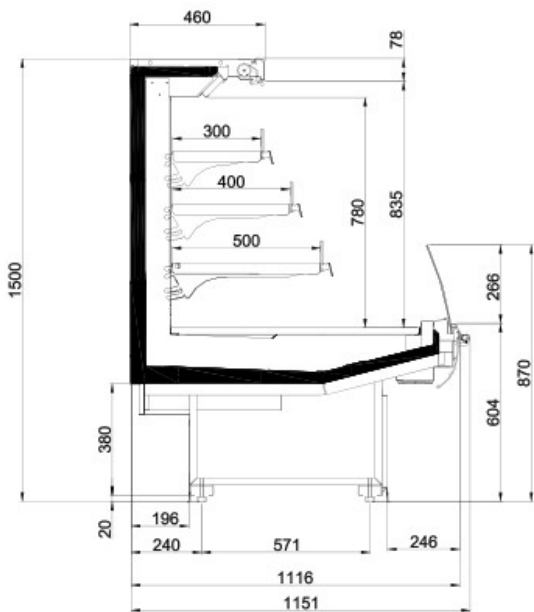

LS-C BC

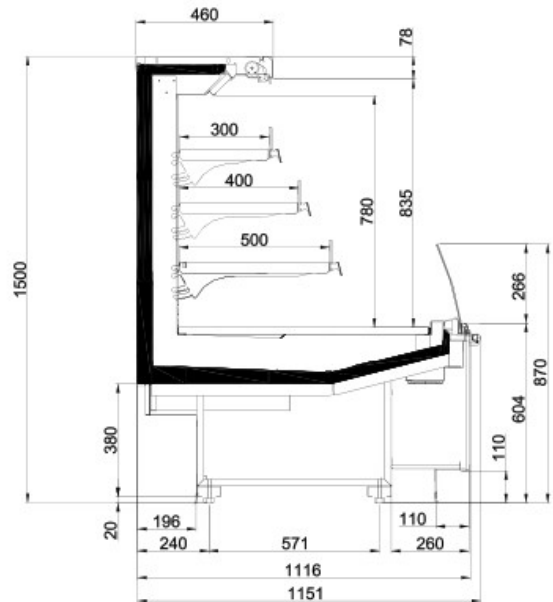

LS-C DESIGN

General Description/总体描述

SV H15

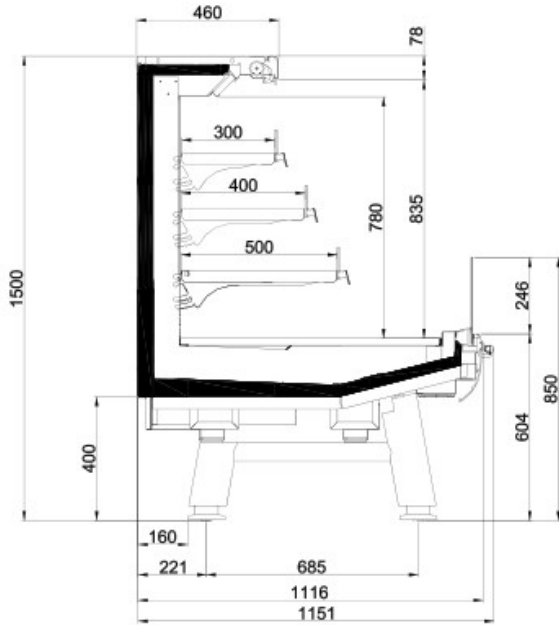

LS-D SB Slim

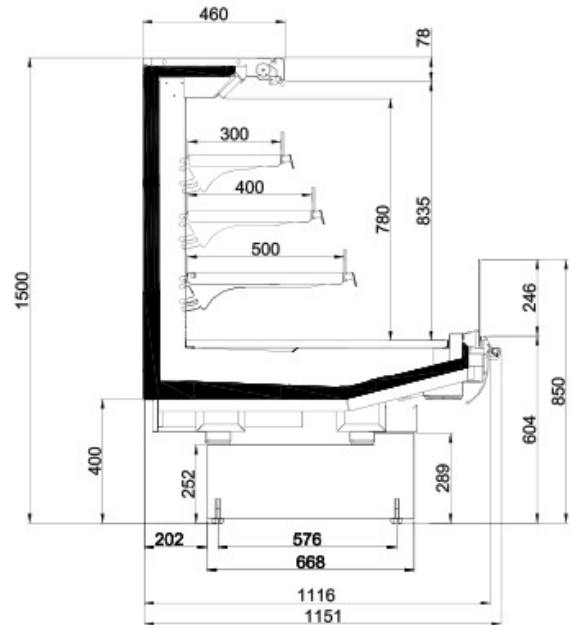

LS-D SB Oval

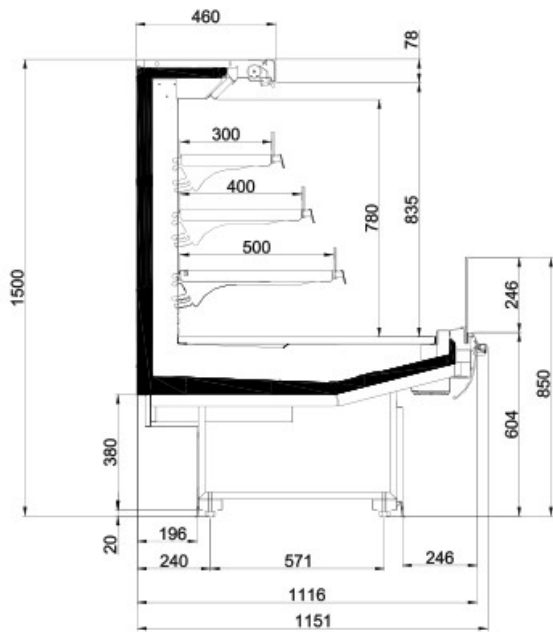

LS-D BC

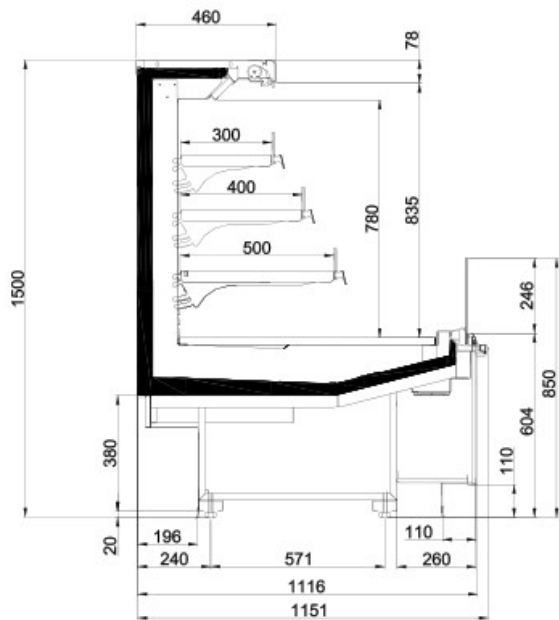

LS-D Design

Cabinet rear side 柜体后侧

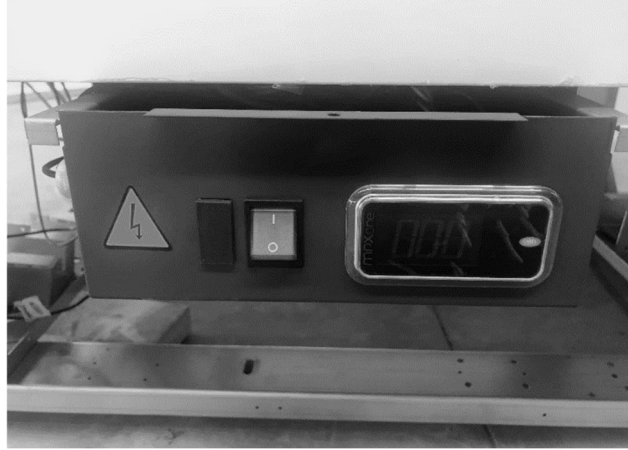

Package / 包装

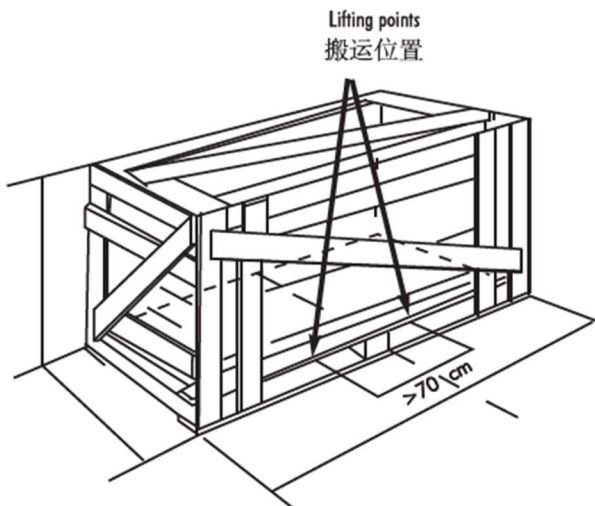

*The weight info will be updated.

Ambient Conditions/使用环境

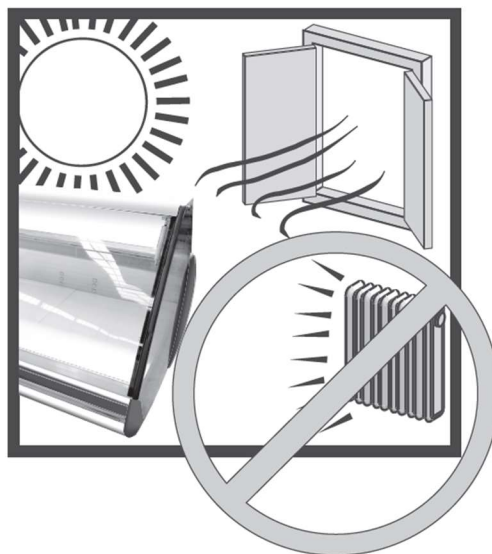

Ambient environment / 使用环境	Closed / 封闭
Temperature / 温度	25° C
Relative humidity / 相对湿度	60% RH
Lighting / 灯光	100 lx

Use of the Cabinet/柜体使用

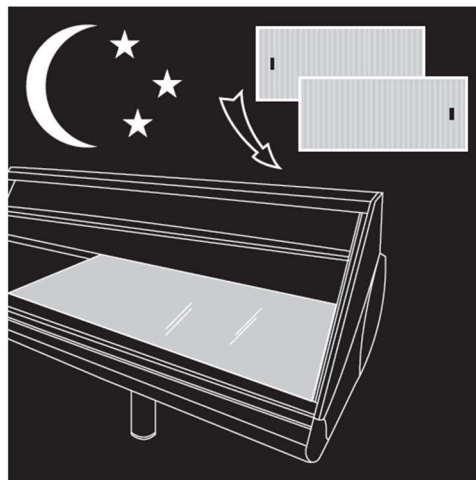

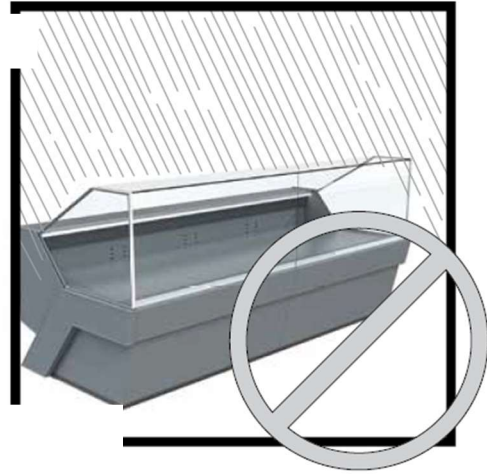
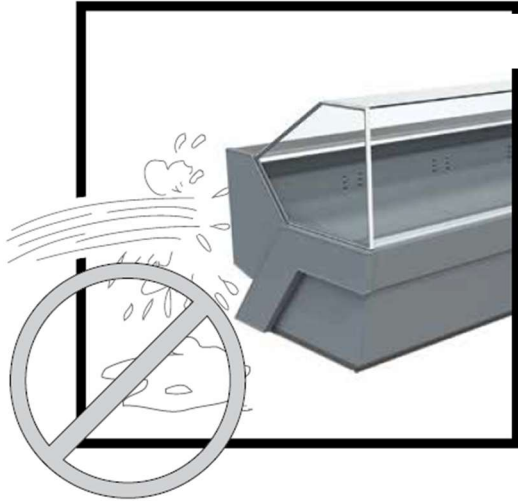

Ordinary Maintenance/日常维护

1.

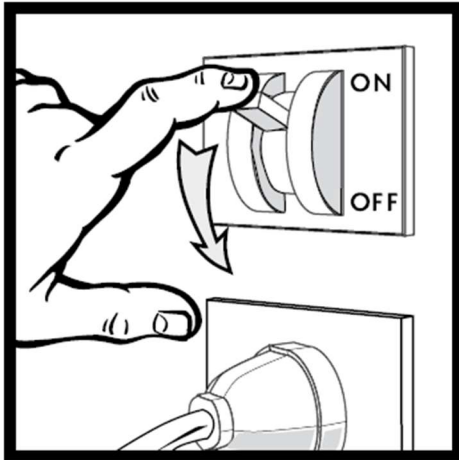

2.



Cleaning Instruction

柜体清洁

Work clothes

- Protective gloves
- Protective clothing
- Safety goggles

Cleaning agent for surfaces other than glass

- Water
- Mild detergent
- Non-scratching sponges, rags and soft cloths

Cleaning agent for glass surfaces

- Water
- Mild detergent
- Standard glass cleaner
- Oil stain removers
- Non-scratching sponges, rags and paper towels

The following must not be used

- Strong corrosive cleaning agents
- Acidic or caustic cleaning agents
- Inflammable agents
- Acetone
- Solvent containing cleaning agents
- Abrasive cleaners
- Jet-wash cleaner or other strong water jet to clean

Cleaning of the refrigerated display cabinet exterior

- Clean the outer surfaces of the display case with mild soap or detergent in lukewarm water only.
- Wipe carefully with non-scratching sponges, rags and soft cloths.

SV option

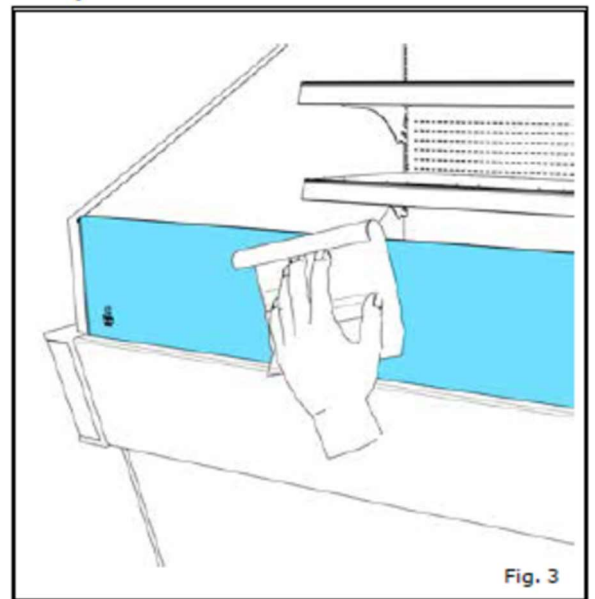

Cleaning Instruction

柜体清洁

Cleaning of the refrigerated display cabinet interior

- Remove the displayed goods into refrigerators or chilled cold rooms.
- Avoid interrupting the cooling chain.
- Disconnect the cabinet from the electrical power supply and secure against re-connecting by unauthorized persons.

Cleaning of the glass doors and glass walls inside:

- Clean it by using standard glass cleaner with a non-abrasive sponge, a rag or a paper towel.

SV option

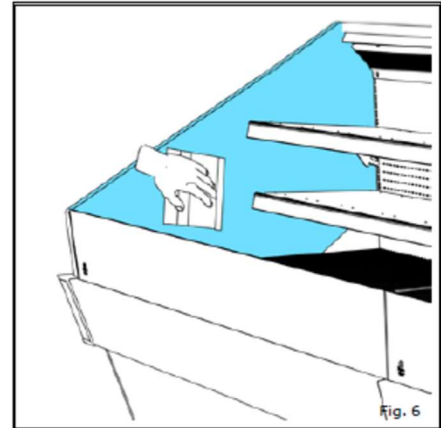

Greasy residue must be removed using oil stain remover.

Cleaning of the shelves:

SV option

- Detach the shelves and take them off the rack.
- Remove the brackets. Make sure that they are in the correct position and they lock completely into the support when you reattach them.

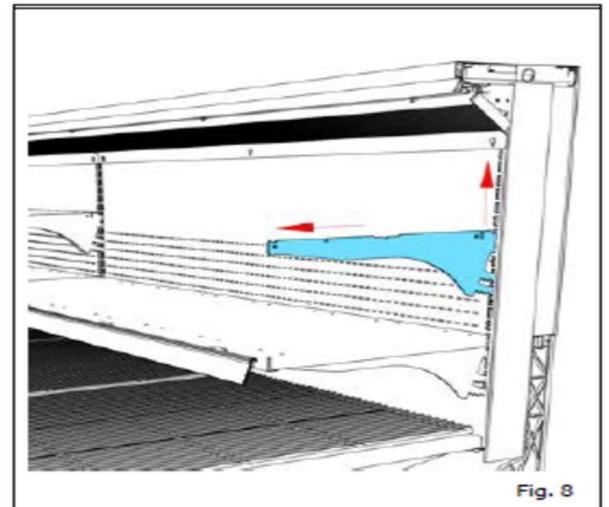
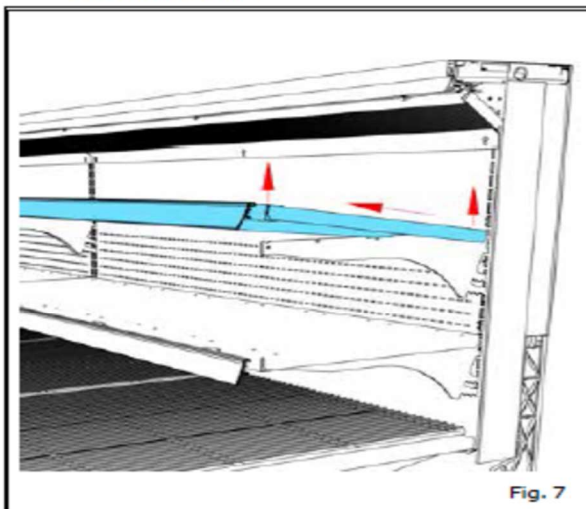

- Clean the shelves by using a moist rag.

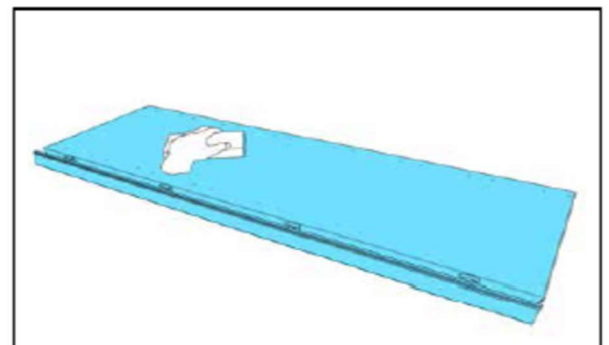

Cleaning Instruction

柜体清洁

Cleaning of the base deck

- Remove the displayed goods into refrigerators or chilled cold rooms.
- Avoid interrupting the cooling chain.
- Disconnect the cabinet from the electrical power supply and secure against re-connecting by unauthorized persons.

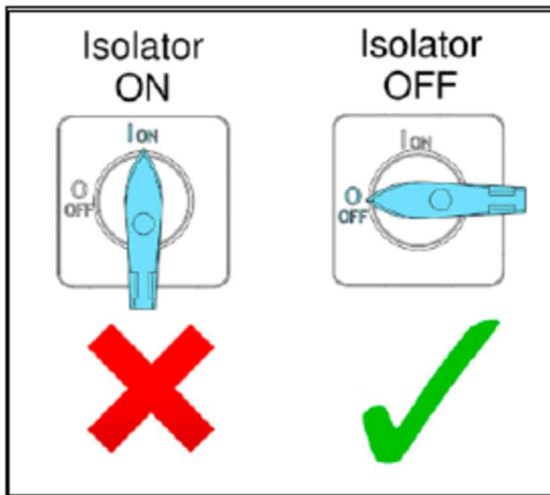

- Clean the base deck by using a moist rag.

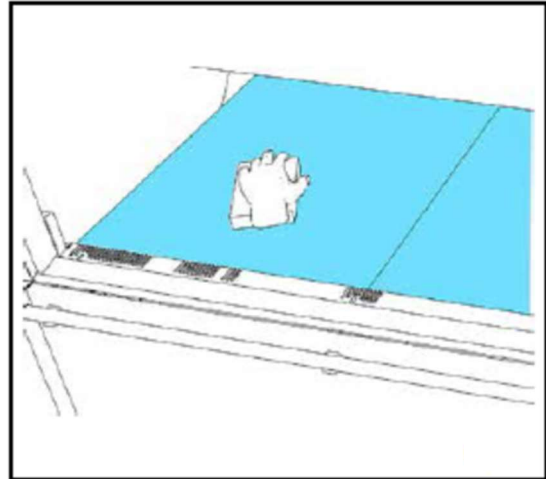

- Take it off.

SV option

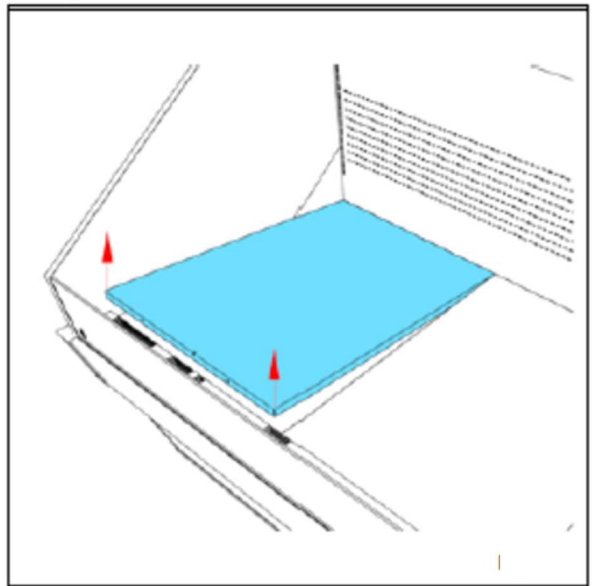

Cleaning Instruction

柜体清洁

Cleaning of the air return grid:

- Remove the air return grid and air discharge grid and clean them by using a moist rag.



Be aware of rotating evaporator fans!
Do not touch them with finger, rags or other tools.

- Clean the base tray with mild soap or detergent in lukewarm water. Check that the drain is unclogged.

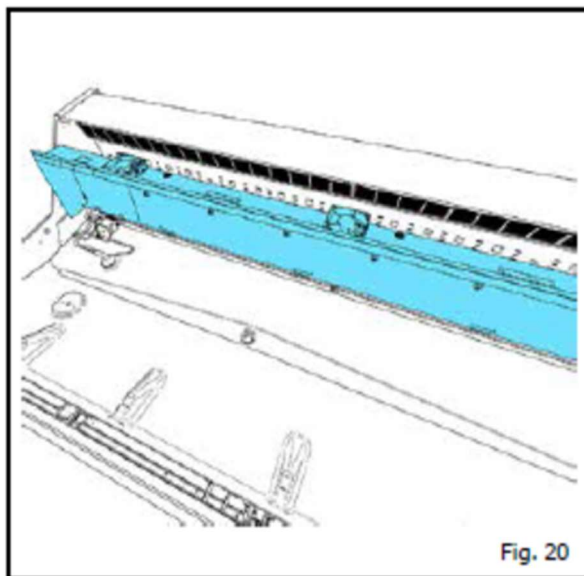
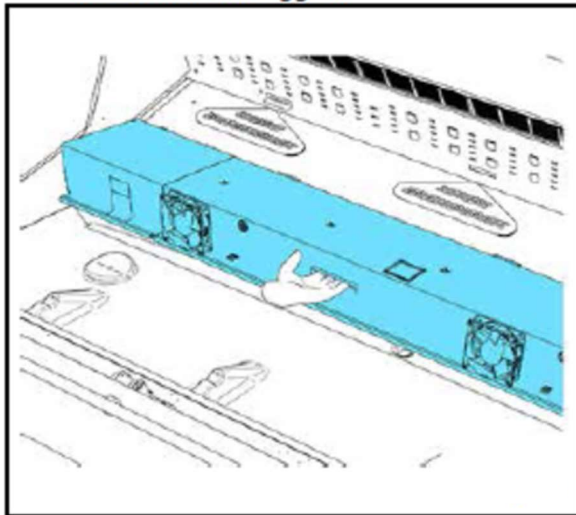
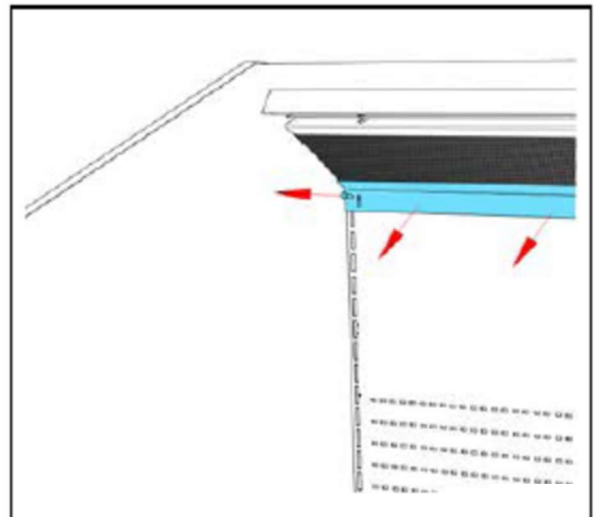
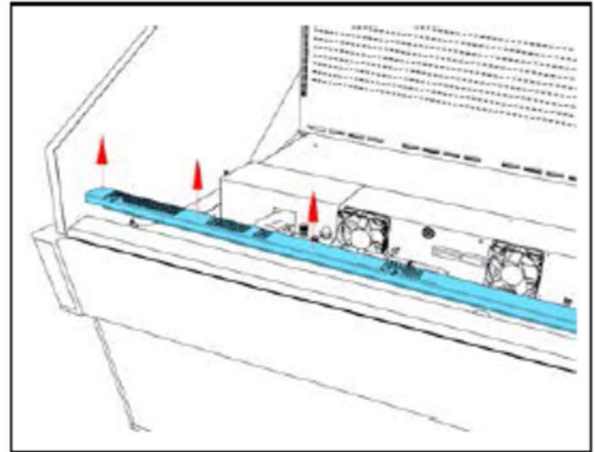
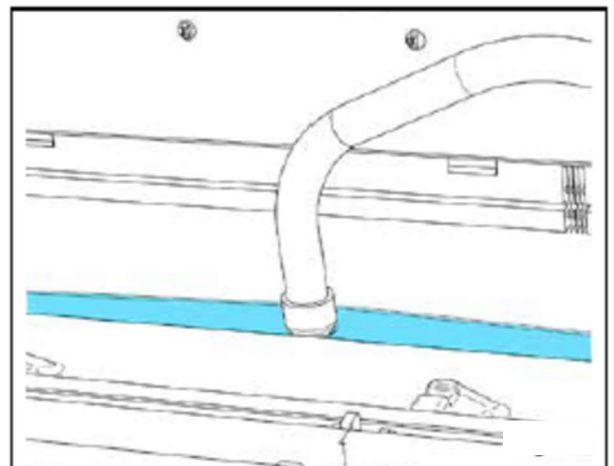

Fig. 20

SV option



- Vacuum inside the drain using a wet vacuum cleanser to remove any particles.



Cleaning Instruction

柜体清洁

- Clean the drainage opening entirely and rinse running water.

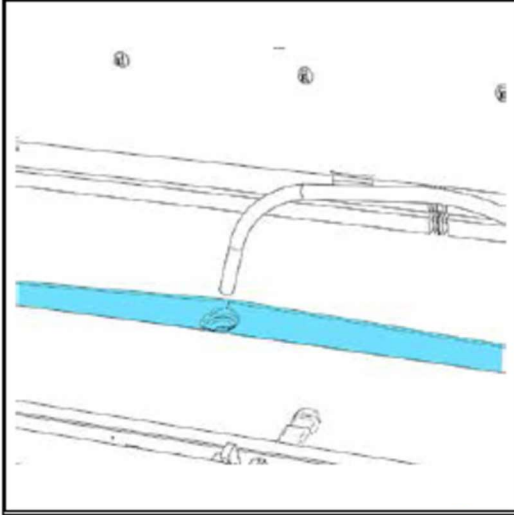

- Reinstall the base deck.

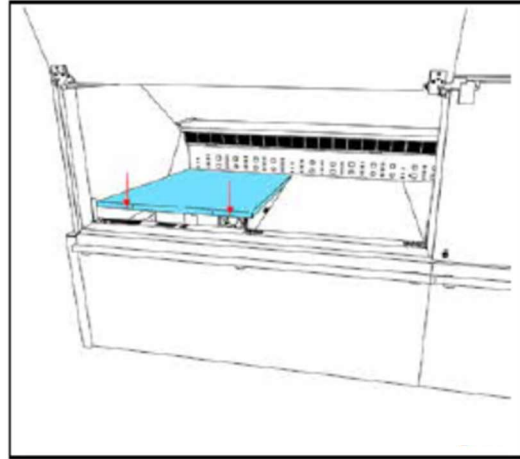

- Reinstall the air return grid.

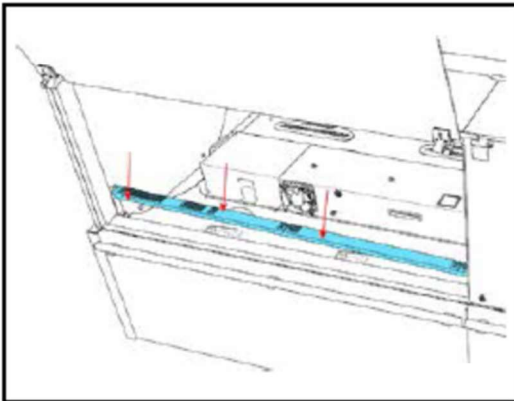

Cabinet restart

- After completing the cleaning and attentively checking that the inside of the cabinet is completely dry, put the appliance back into operation by reconnecting power to the cabinet.
- The cabinet will then start its cooling cycle. Allow cabinets to reach a displayed temperature of -18°C before reloading the removed goods.

1. DESCRIPTION

MELO SV is refrigerated showcases appropriate for the preservation and self-service sale of fresh and/or pre-packed products. Its main features and dimensions are clearly illustrated in general description. A wide variety of optional accessories enabling enhanced functions is also available. To this respect, contact the authorized after-sales service only.

2. TRANSPORTATION

The cabinet is contained in a specially crated package that enables transportation by the use of fork-lift trucks. Handle the machine on its own pallet or on a similar platform; use a fork lift truck, either manual or electric, provided that it is adequate for handling such appliances and it has the requisite lifting capacity. Handling is reserved for the authorized after-sales service.

3. DELIVERY AND STORAGE

Prior to accepting the cabinet from the carrier, check the conditions of the package. If it is showing visible damage, the machine may have suffered some consequences. If so, unpack the machine in the presence of the carrier and sign, with reservation, the delivery bill. The manufacturer disclaims all liability for damage caused by transportation or incorrect handling during storage. Unpacking is reserved for the authorized after-sales service. Storing temperature must be between -25°C and +55°C, air humidity between 30% and 95%. Keep the cabinet away from direct sunlight and from the elements.

4. INSTALLATION AND AMBIENT CONDITIONS

The cabinet must not be installed in premises containing explosive gas substances. It can neither be used in the open nor exposed to the rain.

Prior to connecting the cabinet, make sure that the rating plate data correspond to the characteristics of the existing electrical system in installation manual. For correct operation, the machine must be placed on a level floor, far from sources of heat and/or direct sunlight, doors, windows, fans, or ventilation outlets. It must be granted a reasonable free front area for customer service. The room where the appliance is installed must comply with the requirements set forth.

5. ELECTRICAL CONNECTION

The refrigerator must be installed by professionally qualified personnel, in accordance with the instructions provided by the manufacturer and local regulations. Incorrect installation may cause harm to persons, animals, and property. The manufacturer assumes no responsibility for such damages.

The cord must be spread out safe from shocks, away from liquids, water or sources of heat and it must always be kept in perfect condition. If it should be damaged, have it replaced by duly licensed personnel. **THE USE OF ADAPTOR PLUGS IS FORBIDDEN.**

Make sure that power supply voltage corresponds to the values appearing on the rating plate of the refrigerator. Consider also that the maximum allowable power voltage variation is +/-6%.

IMPORTANT: THE REFRIGERATOR MUST BE PROPERLY EARTHED. The manufacturer disclaims all responsibility for damage resulting from non-observance of this safety principle. If the refrigerator must be installed far from the power points, make certain that the connection complies with the standards in force.

THE MANUFACTURER DISCLAIMS ALL RESPONSIBILITY FOR ANY PERSONAL INJURY OR PROPERTY DAMAGE ARISING FROM INCORRECT INSTALLATION.

6. TECHNICAL SPECIFICATIONS

The built-in electrical installation is composed of control and safety devices lodged in the cabinet. The relevant wiring diagrams and part lists are contained in a sealed plastic envelope together with the present booklet. Keep such documents with the booklet. The technical data are also reported on the rating plate inside the cabinet. The sound level generated by the running refrigerator is below 70 dB (A). The refrigerator generates no harmful vibrations.

WE HEREBY DECLARE THAT THE CABINET AT ISSUE COMPLIES RELATED LAWS AND REGULATIONS.

7. LOADING PRODUCTS

Switch the cabinet on by the wall cutoff switch. As soon as the cabinet is on it will start its cooling cycle. Allow about two hours before loading any products, which must already be at their preservation temperature. THE CABINET IS FACTORY-REGULATED FOR THE ANTICIPATED PERFORMANCE.

ATTENTION! Front glazing can be opened for cleaning and restocking operations. It is advisable to carry out these jobs when the sales area is NOT OPEN TO THE PUBLIC.

When loading products make certain that:

- They are similar in size and type.
- The shelf loading limit (165 kg/sq.m both for the shelf and for the chest) is not exceeded.
- They do not obstruct the flow of refrigerated air.

8. USE

The MELO SV were designed and manufactured exclusively for the display of fresh food like fruits, vegetables, dairy produce, sausages, and fresh meat (CLASSES 3H, 3M2, 3M1). Its function is preserving food temperature, not lowering it. Therefore, when introduced, THE FOODSTUFFS MUST BE AT THEIR CONSERVATION TEMPERATURE. Do not load foods that have undergone heating.

For correct cabinet operation we recommend:

- Loading the products as explained in the preceding section.
- Do not lay heavy weights on the showcase's top surface.

LIGHTING

A switch located on the back of the case controls cabinet lights.

INCLINABLE DISPLAY SHELVES

The rear panel inside the showcase protrudes in some points so that display shelves can be inclined in three different positions by the use of the appropriate supports.

DEFROSTING

The number and duration of defrosts are factory-set. The user must never alter their adjustment. Defrost-water is collected by a drain tube and conveyed into a drainage system. Periodically check that defrost water flows off normally. Otherwise, unclog using a pointless flexible probe.

9. PRESCRIPTIONS AND RESTRICTIONS

KEEPING PHARMACEUTICAL PRODUCTS, GLASS BOTTLES OR FLASKS IN THE SHOWCASE IS STRICTLY FORBIDDEN as they could get broken and entail a safety hazard.

Resting the unpackaged food items directly on the decks should be avoided; use suitable food containers instead.

DO NOT REMOVE COVERS OR PANELS WHEN IT REQUIRES THE USE OF TOOLS AND ESPECIALLY DO NOT REMOVE THE ELECTRIC CONTROL BOARD COVER.

Do not expose the showcase to atmospheric agents.

Do not spill water directly or indirectly on the showcase. Do not touch the machine with damp or wet hands or feet; do not use it while barefoot.

ATTENTION: The refrigerating system does not alter defrost water in any way, which is the product of the steam contained in the air circulating inside the showcase. Defrost water and wash water may nonetheless mix with pollutants deriving from the products preserved in the appliance, from preservation means, from product remains, from the accidental crush of recipients containing liquids or from the use of improper detergents.

THE WATER PRODUCED BY THE SYSTEM MUST THEREFORE BE DISPOSED OF THROUGH A SEWER OR PURIFICATION SYSTEM IN COMPLIANCE WITH THE REGULATIONS IN FORCE.

ANY OTHER USE NOT EXPLICITLY MENTIONED IN THIS BOOKLET MUST BE CONSIDERED AS HAZARDOUS. THE MANUFACTURER DISCLAIMS ALL LIABILITY FOR ANY DAMAGE RESULTING FROM IMPROPER, INCORRECT OR UNREASONABLE USE.

10. ORDINARY MAINTENANCE

ATTENTION! BEFORE STARTING ANY MAINTENANCE OR CLEANING, DISCONNECT THE EQUIPMENT FROM THE ELECTRICAL POWER SUPPLY USING THE MAIN WALL CUT-OFF SWITCH.

IMPORTANT: During maintenance or cleaning operations, be sure that the light in the working area is sufficient. If necessary, use an additional source of light. Mind also the hot and moving parts marked with the relevant symbol. The use of heavy-duty gloves is recommended.

ATTENTION! Front glazing can be opened for cleaning and restocking operations. It is advisable to carry out these jobs when the sales area is NOT OPEN TO THE PUBLIC.

CLEANING THE CABINET

- 1) Every week clean the outer surfaces of the showcase with mild soap or detergent in lukewarm water only. Wipe carefully with a soft cloth. Never clean it using inflammable or scouring agents, alcohol, acetone or solvents; Do not use detergent containing nonionic surfactants, lemon o vinegar (acetic acid). NEVER CLEAN THE DISPLAY CASE BY THE USE OF WATER JETS. Clean glass surfaces using glass-cleaning products only. The use of water is not recommended here, as it may cause scale to build up.
- 2) Every month clean the cabinet inside surfaces following the instructions provided in the preceding item,

only using a non-abrasive sponge (the maximum temperature of the usable water for the cleaning is of 65°C) and those indicated here below:

- Disconnect the cabinet from the power mains using the wall main cutoff switch.
- Empty the appliance, store its contents in cold-rooms or refrigerators that are adequate for keeping the requisite preservation temperature.
- Wait until the showcase has reached ambient temperature and then clean according to the above instructions. The incorporated drain facilitates the collection of wash water by conveying it directly outside the cabinet.
- After having carefully checked that the cabinet is completely dry, reassemble it and switch it on.
- Allow a couple of hours before loading the products back again.

NOTE: to ease the cleaning of internal parts, the cabinet is provided with easy-to-remove inner walls on the air-outlet side. ATTENTION: MAKE SURE THAT THE INNER WALLS ARE PUT BACK IN PLACE. To clean the base deck it is also possible to turn the fan holder upwards.

- 3) Defrost the showcase every three months to let the ice that may have formed between the evaporator fins melt, since frost may otherwise prevent correct operation. Proceed according to the instructions for cleaning the inside surfaces at item 2 but allow a longer wait time for the ice to melt completely. Any maintenance operation not dealt with above, must be carried out by the authorized after-sales service or by qualified personnel.

11. EMERGENCY SITUATIONS

- 1) The cabinet will not start or will not keep on working:
 - There may be a general blackout;
 - The wall main switch may be off;
 - The plug of the appliance may be out of the socket.

If power failure is not due to any of the above causes, call the nearest after-sales service immediately, empty the cabinet and store the foods in cold rooms or refrigerators that may ensure their preservation temperature.

- 2) The cabinet will not start or will not keep on working:
 - make sure that the product load is correct;
 - if the showcase has not been defrosted for longer than 3 months, defrost and clean it before starting normal operation;
 - make sure that the case is not exposed to sources of heat or draught;
 - make certain that ambient conditions comply with the requirements in page 12;
 - check that the showcase is perfectly horizontal using a spirit level.

Should insufficient cooling persist, resort to the nearest after-sales service.

IN CASE OF A GAS LEAK OR FIRE, do not breathe inside the room that houses the cabinet before having aired it properly. Turn the cabinet off by the main switch ahead (in page 14). DO NOT USE WATER BUT ONLY DRY EXTINGUISHERS TO PUT OUT THE FIRE.

3) The cabinet operates noisily:

- make sure that screws and bolts are securely closed;
- check that the showcase is perfectly horizontal by the use of a spirit level;

Check that the showcase is perfectly horizontal by the use of a spirit level. Should the inconvenience persist, resort to the nearest after-sales service.

12. AFTER-SALES SERVICE

Should it be necessary to resort to technical assistance, contact your salesperson immediately.

If spare parts are needed, always refer to your after-sales service: insist on the use of original spare parts.

13. DISMANTLING AND DISPOSAL

For the sake of the environment, please sort the parts and materials composing the cabinet in accordance with the waste disposal provisions in force in your country, so that they can be properly disposed of or recycled. All its parts cannot be treated as household waste, except for the metal parts, which nevertheless are not considered as special waste in most European countries.

THE PARTS COMPOSING THE REFRIGERATING CIRCUIT MUST NOT BE SEVERED OR SEPARATED BUT DELIVERED INTACT TO A CENTRE SPECIALISED IN RECYCLING REFRIGERANT GAS.

1. 概述

MELO SV 半高柜该系列展示柜用于保存新鲜蔬菜水果及预包装产品等。具体特征及尺寸见总体描述。多种配件供不同卖场选择，具体请联系授权经销商。

2. 运输

陈列柜都包装在特殊的木箱或木托盘以便于叉车运输。将设备搬运到自带的托盘或类似平台上，使用有足够举重能力的手动或电动的升降式叉车搬运陈列柜。由指定的售后服务商实施搬运。

3. 交货和存放

在签收货物前，请先检查陈列柜的外包装。外包装的损坏有可能引起陈列柜的损伤。如果外包装确有损坏，请在货运商面前拆箱并在交货单上签字标注，请保管好交货单并保留对承运商索赔的权利。厂商对因运输或在存放中的不正确搬运而引起的损坏不承担任何责任。拆箱工作应由指定的售后服务商进行。陈列柜的存放温度介于-25℃和55℃之间，空气湿度在30%和95%间。陈列柜要远离阳光直射和电子元件。

4. 安装和使用环境

陈列柜绝对不能安装在含有爆炸性气体的房屋里，也不能在露天或雨中使用。在连接陈列柜前，请确认陈列柜铭牌中的数据与实际陈列柜相符，参考安装手册相关信息。正确的操作：将陈列柜放在水平地面上，远离热源和（或）阳光直射、门、窗、风扇或通风口。在陈列柜前方要留出适当的空间便于顾客取货。安装陈列柜的房间里必须符合列出的要求。

5. 电气连接

陈列柜的安装必须由专业人员按照厂商提供的使用说明书和当地的规定进行。厂商对因不正确的安装造成的对人、动物的伤害及财产损失不承担任何责任。

电线必须安全展开，远离液体、水或热源并且保持良好的使用状况。如果损坏，请有正式授权的人员更换。

禁止使用适配器插座。

确认电源电压符合陈列柜铭牌中标明的电压数值。请注意最大的电压变化范围为 $\pm 6\%$ 。

重要事项：陈列柜必须正确接地。厂商对因不遵守这一安全准则而造成的一切危险后果不承担任何责任。

如果陈列柜必安装在远离电源地方，须确保电路按照国家规定正确连接。

厂商对因错误电气安装而引起的任何人身伤害或财产损失都不承担任何责任。

6. 技术规格

陈列柜内置的电气装置由控制器和嵌入陈列柜里的安全器件组成。相关线路图和部件清单跟用户使用说明书在同一个密封塑料袋里。请将这些文件和用户使用说明书一起保管好。陈列柜的铭牌上标明了相关技术参数。陈列柜运行时产生的噪声低于 70 分贝。我们在此声明陈列柜符合可与食物接触的物料的规定。

7. 装货

陈列柜通过墙面电源开启。陈列柜电源开启即会启动制冷系统。陈列柜装货前需运转两小时才能达到保鲜所需温度。陈列柜的预期性能已作了出厂设置。

摆放商品时请确保：

- 大小品类一致；
- 层板最大承重为165kg/m²，请不要超过最大承重量；
- 商品不要覆盖出风口，影响柜内空气流通。

8. 使用方法

陈列柜适用于摆放预包装的新鲜食品，饮料和奶制品（环境温度3H-3M2-3M1），它的作用是保持食品的温度，而不是降低温度，因此：在放入陈列柜时，食品类商品的温度必须已处于适宜保存的温度。

我们推荐正确的操作：

- 按照前面章节的介绍摆放商品；
- 柜子右侧上方配置有控制灯和温度计的开关，面板温度显示器可以控制温度。

注意：所有的调节必须由专业人员操作。

9. 规定和限制

严格禁止将药剂产品放在陈列柜里。

除了因清洗冷凝器需取下冷凝器防护装置外，不能移动需要用工具才能取下的盖子或者面板，尤其是不能移动电控箱盖。

不能将陈列柜放在室外。

不要踩陈列柜的防撞保护杠。

不要踩在陈列柜上方，不要在陈列柜上方置物。

不能直接或间接的将水倒在柜体上。

不能用湿的手脚接触陈列柜，赤脚时不能操作陈列柜。

相关设备的安装必须由制造商授权的专业技术人员进行。

不要让身体受伤的人、感官受损的人、精神失常的人、儿童以及缺乏经验和知识的人使用此冷柜，除非有负责他们安全的人员在场。对于儿童应该执行监管不让他们在制冷陈列柜旁玩耍。

本说明书中未说明的其他用途都是危险的。厂商对因不规范的、不正确的或者不合理的使用而产生的一切损害不承担任何责任。

10. 日常保养

每周清洗陈列柜的外表面，请用温和型肥皂或溶在冷水里的清洗剂，用软布仔细擦拭。不能使用可燃的、洗涤剂、酒精、丙酮或溶剂。不能用水枪冲洗陈列柜。只能用玻璃清洁产品清洁玻璃。这里不建议使用水，因为有可能使污垢增多。

每月按照前面提及的和以下说明的指导清洁陈列柜的内部表面：

- 使用墙上主开关给陈列柜断电；

- 取出陈列柜中存放的物品，把这些物品转放到冷库或者其它有足够的达到保鲜要求能力的冷藏设备里；
- 等到陈列柜的温度达到室温后，按照上面提到的方法清洁；仔细检查确认陈列柜已经完全干燥后，重新安装并开启陈列柜电源；
- 空载运行几小时后，将物品重新放回陈列柜。

每3个月陈列柜需对蒸发器片间进行除霜，结霜在不同程度影响陈列柜正确的工作。按照清洁内部表面的方法进行，允许等待稍长的时间完全融霜。

每六个月按照以下步骤清理一次蜂窝网：

- 松动顶部支撑螺丝；
- 取下蜂窝网；
- 用低于70° C的温水清洗蜂窝网中的灰尘；
- 干燥蜂窝网。

上述没有涉及到的任何保养操作都必须由指定的售后服务或者有资格的人员进行。

11. 突发状况

陈列柜不能启动或者不能继续工作：

- 可能是停电；
- 墙面电源关闭；
- 陈列柜的电源插头和电源插座接触问题。

如果不是因为上述原因导致电的问题，请立即联系最近的售后服务商，清空陈列柜并将食品转存到冷库或者别的能确保食品保鲜的冷藏设备里。

陈列柜制冷不正常：

- 确保正确的往陈列柜里放货的方法；
- 如果陈列柜超过3个月没有除霜，在正常操作前先除霜和清洁；
- 确认陈列柜没有暴露在热源或者干燥环境里；
- 确认环境条件和用户手册中的要求相符；
- 使用水平仪检查陈列柜是否水平放置。

如果陈列柜继续制冷不足，请与最近的售后服务商联系。

柜子运转有噪声：

- 确认螺丝螺栓已经拧紧；
- 使用水平仪检查柜子是否水平放置。

假如有气体泄漏或者起火，在空气流动正常前，需在放置陈列柜的房间里屏住呼吸。关闭柜子的电源给柜子断电，不能用水要用灭火剂来灭火。如果问题继续存在，请与最近的售后服务商联系。

12. 售后服务

需要技术帮助的时候请立即与销售人员进行联系。

如果需要配件，与售后服务商联系：要坚持使用原装配件。

13. 分解和处理

为了保护环境，请按照本国垃圾处理法规规定来分类存放陈列柜的部件和材料，从而可以将这些物料正确处理和回收。所有的部件不能被当作城市固体废物，金属部件除外，大部分国家金属部件不被认为是特殊垃圾。组成制冷系统的部件不能重新利用或者单独使用，只能完整的送往专业回收制冷设备的中心。